



Pump specifications:

Type.....	BA150E D285
Max. flow	500 m3/hour (2200 US GPM)
Max. pressure	38 mwc (125 ft.)
Connections.....	DN150 (6")
Solids handling	80 mm (3,15")
Impeller type	Semi-open impeller
Priming system	BBA MP50
Engine	Hatz 4H50TICD
Emission level.....	Stage V
Canopy	M10-23X
Sound level.....	64 dB(A) at 10 m
Dry weight.....	1675 kg (3685 lbs.)

FEATURES

BA auto prime pump

The BA range of pumps has been designed with a clear focus on reliability, efficiency and durability. Featuring a 100% mechanical priming system, the BA series pumps quickly prime and re-prime, even from dry conditions. The heavy build style of both pump and canopy make the BA range perfect for use in the strenuous contractor market.

World-class performance

The BA range is built to be deployed on the most demanding dewatering and sewage bypassing applications. Using high efficiency pumps and state-of-the-art diesel engines, the pumps offer maximum performance at minimal cost, fully in-sync with the company philosophy of "Lowest cost of ownership".

Sustainability

- High efficiency pumps minimising fuel consumption
- Corrosion free hot dip galvanized canopy
- Corrosion free composite door panels and powder coated plating
- 100% Oil-spill free priming system
- Fully bunded unit eliminating fuel/oil spills at all times

Complete package designed & built by BBA Pumps

- Complete in-house design & production
- Over 60 years of experience in the market
- Extensive testing facility in-house
- Contemporary & functional design
- Durable & eco-friendly materials
- Custom builds available

After sales service & product support

- Single supplier for parts, spares & accessories
- Dedicated customer help-desk (24h service)
- Dedicated service department in-house
- Global parts distribution network
- Optional global on-site servicing
- Extensive training options available (technical & commercial), on-site or in-house

PERFORMANCE CURVES (1900 RPM)

Continuous duty according ISO 9906

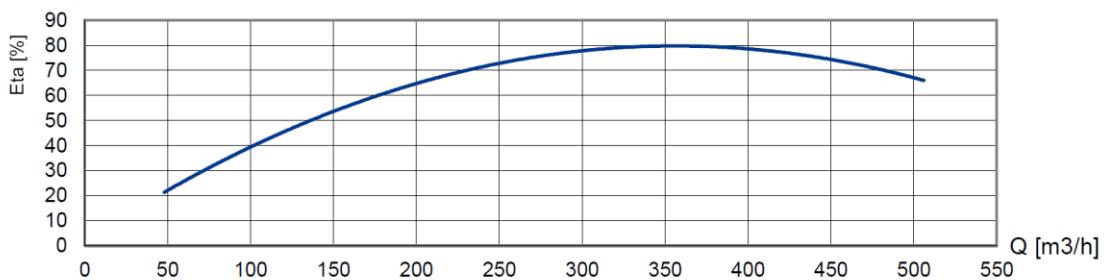
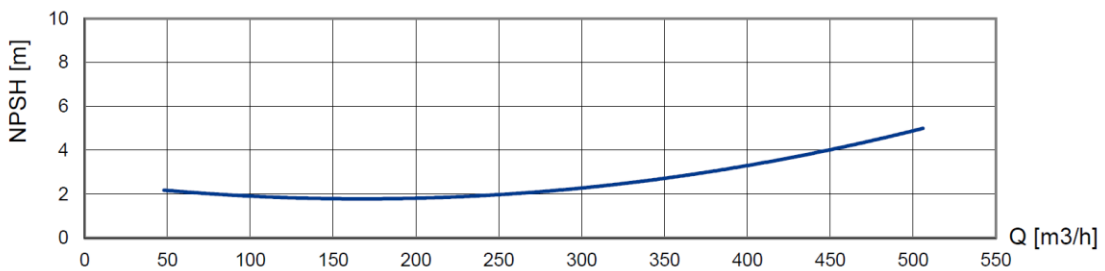
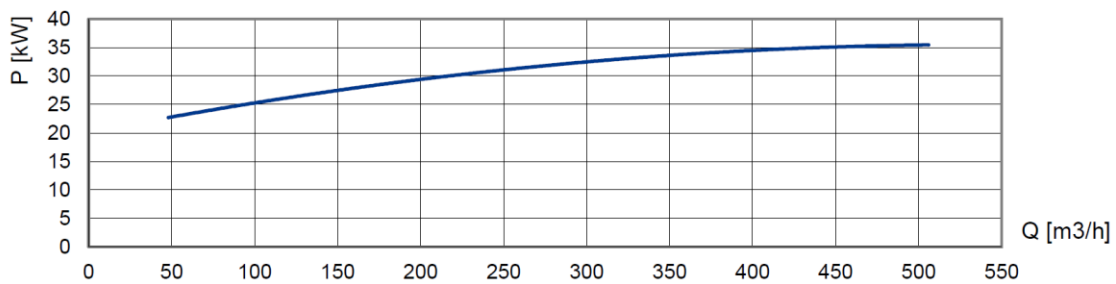
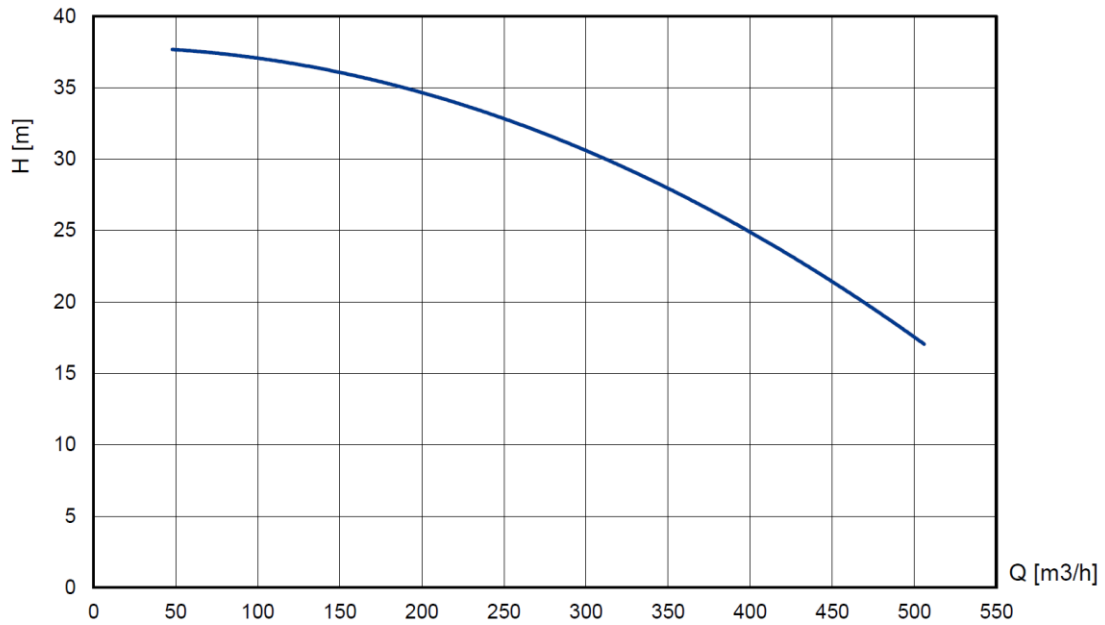

STANDARD TECHNICAL SPECIFICATIONS

BBA auto prime pump

Pump type.....	BA150E D285
Max. flow.....	500 m ³ /hour (2200 US GPM)
Max. head.....	38 mwc (125 feet)
Impeller type.....	Semi-open impeller
Solids handling.....	80 mm (3.15 inch)
Pump casing.....	Cast iron GG20
Impeller.....	Chrome Moly 42CrM04
Self-cleaning wear plate.....	Chrome Moly 42CrM04 (cutter slots)
Pump shaft.....	C45
Shaft seal.....	Mechanical seal
Seal faces.....	Tung/Sic
Seal rubber.....	Viton



BBA priming system

Pump type.....	BBA MP50 Diaphragm pump
Air handling capacity.....	50 m ³ /h (30 CFM)
Max. vacuum.....	8.5 m (29 inHg)
Drive.....	Toothed belt (continuous drive)
Float box.....	Aluminium
Non return valve.....	Cast iron GG25
Check valve disc.....	Buna-N



Engine

Engine brand.....	Hatz
Engine type.....	4H50TICD
Max. power IFN.....	55.4 kW (75 Hp)
Variable engine speed.....	1300 - 1900 RPM
Fuel consumption.....	220 g/kWh
Displacement.....	1,952 cm ³
Number of cylinders.....	4
Aftertreatment.....	EGR, DOC, DPF
Emission level.....	Stage V

BBA control panel LC40

- Auto start/stop system
- Two float switches included (10m cable)
- Key switch
- Rpm. control with push buttons
- Warning lights
- 4.3" LCD display

The LCD monitor displays additional engine data, e.g. actual engine speed, working hours, battery voltage, fuel consumption and failures in clear text (Multilanguage support)



Fuel system

- Composite fuel tank 300 L (80 US Gallon)
- Fuel tank cap Ø 100 mm (4 inch)
- Electronic fuel injection system

Electrical system & safety features

- Nominal voltage 12 Volt
- Premium quality battery
- Low oil pressure shut down

CANOPY M10-23X

BBA sound attenuating canopy

Canopy type.....	M10-23X
Dimensions L x W x H	2270 x 1050 x 1595 mm
Dimensions L x W x H	89.4 x 41.3 x 62.8 inch
Basic frame	Hot dip galvanized
Roof panel	Composite roof panel
Doors	5 lockable composite doors
Fuel tank	PE net 300 ltr (80 US Gallon)
Fuel tank autonomy	30 hours (at 1900 rpm BEP)
Fuel tank cap	100 mm (4 inch)
Electrical isolation	Battery isolator switch
Forklift pockets.....	Fitted with 2 forklift pockets
Lifting point	Fitted with single lifting point
Stackable	Canopy is stackable
Exhaust system	Fully integrated in canopy
Additional	Fitted with oil-water separator
Connections.....	Please consult "auxiliary items" in overleaf
Documentation box.....	BBA user manual and warranty book

BBA E-lift® system

The M10-23X canopy has been fitted with the BBA E-lift® system. By removing the roof panel, the pump and diesel engine as a whole can be removed from the canopy effortlessly allowing easy preventative maintenance on the pump and diesel engine. In addition, as the canopy is not fitted with padding or insulation materials, it can be cleaned quickly using a pressure washer.

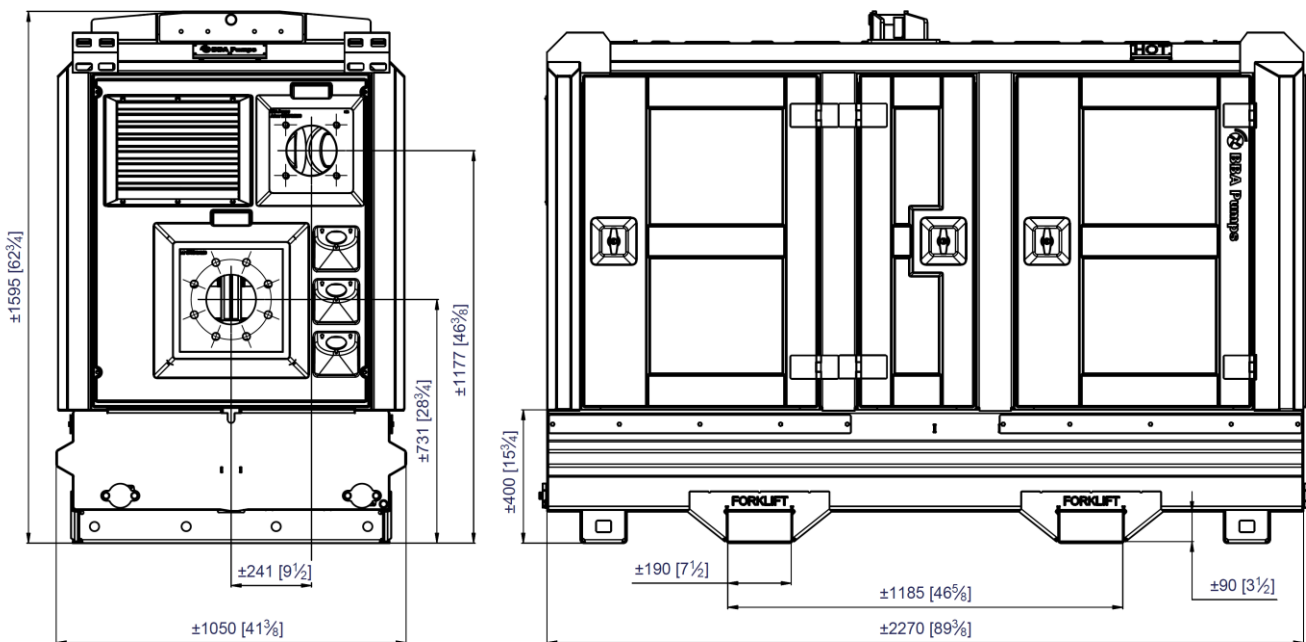

Actual dimensions (in mm & inches) may vary depending on selected quick couplings.



Semi-open impeller
Corrosion and abrasion resistant Chrome Moly (42CrM04) alloy.



Fuel tank
Fully bunded, corrosion-free, 300 liter, high-density polyethylene (HDPE) fuel tank, located in base of canopy.



Safety
Extremely durable and lockable T-locks offering perfect grip.

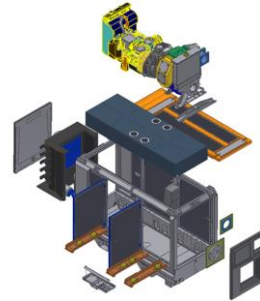

Speedy servicing
By removing the roof panel, the pump and diesel engine as a whole can be removed from the canopy effortlessly allowing easy preventative maintenance on the pump and diesel engine.



Large inspection covers
Easy access to float box, impeller and non-return valve.



Easy inspection
Oil glasses, drain valves and fill plugs are all easily accessible.



4 Year limited warranty
The BBA limited warranty covers years or operating hours whichever occurs first. For more details please consult the BBA warranty book.



User Manual BA series
Extensive user manual with important information concerning the pump unit, pump installation and safety warnings. Available in several languages.

Pictures used are for illustration purposes only.

AUXILIARY ITEMS
Discharge connections

Art.nr.		Ø inch	Ø mm	Connection	
5080873	30°	6	150	Flange K240	
1516604209	30°	8	200	Flange K295	
5080876	30° female (cup)	6	150	System B	
5080881	30° male (ball/lever)	6	150	System B	
5080877	30° male (ball)	6	150	System C	
5080882	30° female (cup/lever)	6	150	System C	

Suction connections

Art.nr.		Ø inch	Ø mm	Connection	
5080884	30°	6	150	Flange K240	
1516604208	30°	8	200	Flange K295	
5080889	30° female (cup)	6	150	System B	
5080890	30° male (ball/lever)	6	150	System B	
5080887	30° male (ball)	6	150	System C	
5080888	30° female (cup/lever)	6	150	System C	

Suction hose with strainer L=5 metre

Art.nr.	Ø inch	Ø mm	Connection	
7047054	6	150	Flange K240	
7047057	8	200	Flange K295	
7047007	6	150	System B male (ball/lever)	
7047037	6	150	System C female (cup/lever)	

Suction hose with strainer L=6 metre

Art.nr.	Ø inch	Ø mm	Connection	
7047055	6	150	Flange K240	
7047058	8	200	Flange K295	
7047008	6	150	System B male (ball/lever)	
7047038	6	150	System C female (cup/lever)	

Recommended suction pipe diameter (maximum velocity = 4 m/sec)

M3/H	US gallons	FLOW (L/sec)	4"	5"	6"	8"	10"	12"
			100	125	150	200	250	300
252	1110	70	8.91	5.70	3.96	2.23	1.43	0.99
288	1268	80	10.19	6.52	4.53	2.55	1.63	1.13
324	1427	90	11.46	7.33	5.09	2.86	1.83	1.27
360	1585	100	12.73	8.15	5.66	3.18	2.04	1.41
403	1775	112	14.26	9.13	6.34	3.57	2.28	1.58
432	1902	120	15.28	9.78	6.79	3.82	2.44	1.70
468	2061	130	16.55	10.59	7.36	4.14	2.65	1.84
504	2219	140	17.83	11.41	7.92	4.46	2.85	1.98